

**SERVICE  
MANUAL**

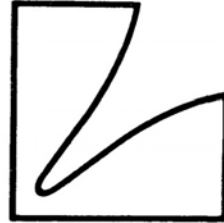

L-550

Duo-Beta Circuit/S  
Stereo Integrated Amplifier

**L-550**

Pure Class A

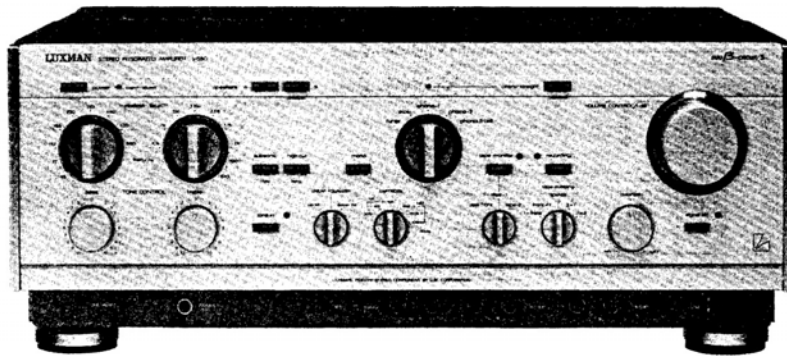

MC-Service

# Contents

Block Diagram	1
Adjustment Locations	2
Adjustment Procedure	3
調整手順書	4
Exploded View Parts List	5, 6
Packing Material Parts List	7
PCB PB-1399 Parts List	8
PCB PB-1400 Parts List	8, 9
PCB PB-1400-1 Parts List	10
PCB PB-1400-2 Parts List	10, 11
PCB PB-1400-3 Parts List	11
PCB PB-1400-4 Parts List	12
PCB PB-1401 Parts List	12
PCB PB-1401-1 Parts List	12, 13
PCB PB-1401-2 Parts List	13
PCB PB-1401-3 Parts List	14
PCB PB-1401-4 Parts List	14
PCB PB-1401-5 Parts List	14
PCB PB-1401-6 Parts List	14
PCB PB-1401-7 Parts List	14
PCB PB-1401-8 Parts List	15
PCB PB-1402 Parts List	15
PCB PB-1402-1 Parts List	16
PCB PB-1402-2 Parts List	17
PCB PB-1402-3 Parts List	17
PCB PB-1402-4 Parts List	18
PCB PB-1402-5 Parts List	18
PCB PB-1402-6 Parts List	18
PCB PB-1402-7 Parts List	18
PCB PB-1402-8 Parts List	18
PCB PB-1403, 1403-1 Parts List	18, 19
PCB PB-1403-2, -3 Parts List	19
Miscellaneous Parts List	20
Destination's Parts List	20
IC Handling Guide	21
Schematic Diagram	22, 23
Specifications	24

## L-550 Block Diagram

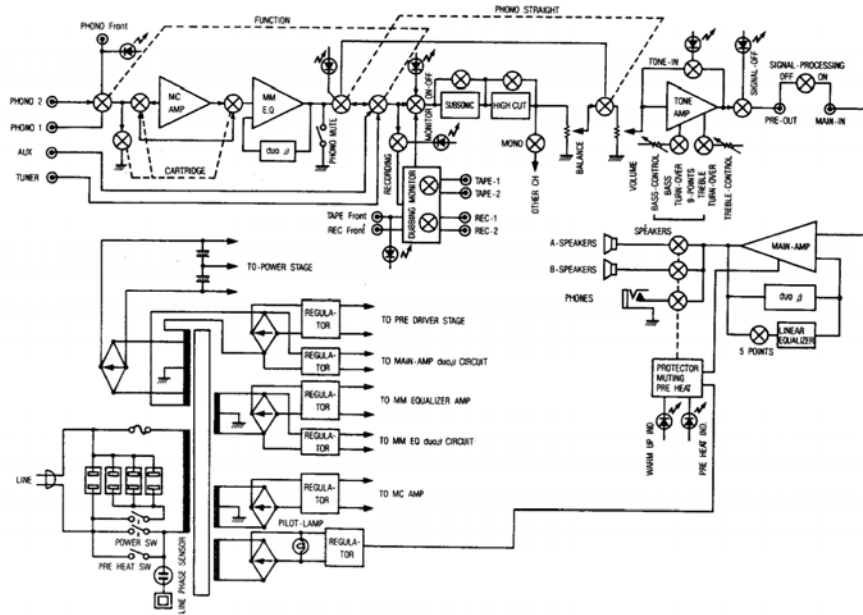

### L-550 Packing Material Parts List

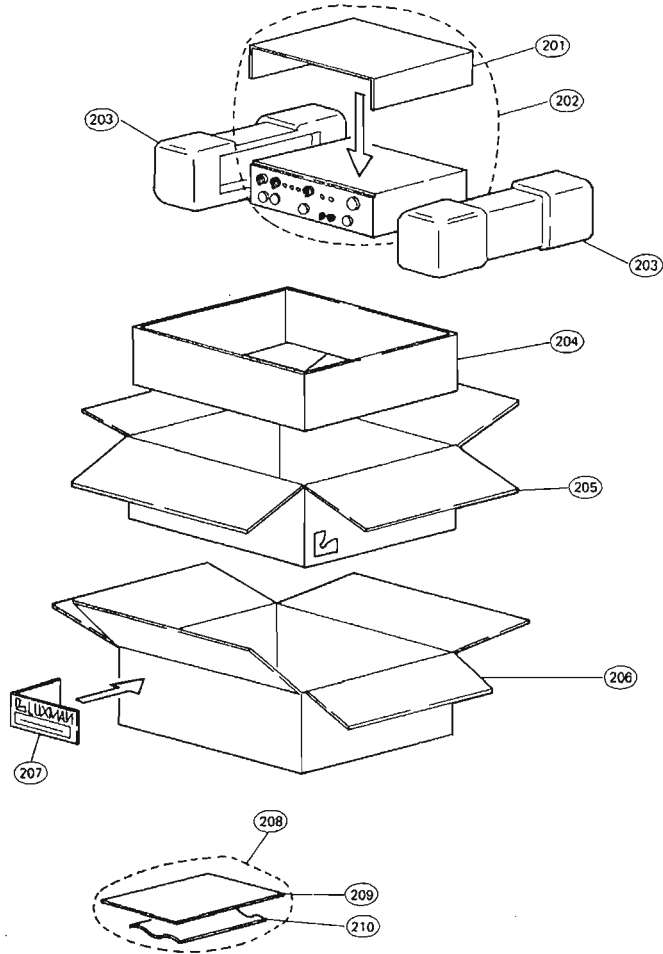

Symbol No.	Stock No.	Description
201	WZ1011	Paper, Protector
202	XC1028A	Sack, Poly
203	XB1057	Pkg, Tray
204	XD1050	Pad
205	XAL304	Carton, Pkg.
206	XH1056	Outer Carton
207	XG1068	Label, Voltage (120V)
	XG1069	Label, Voltage (220V)
	XG1070	Label, Voltage (240V)
208	XC1031	Sack, Poly
209	ME0211	Owner's Manual (EX)
	MA0151	Owner's Manual (J)
210	WZ1204	Duster

## L-550 Exploded View Parts List

Symbol No.	Parts No.	Description	Q'ty	Symbol No.	Parts No.	Description	Q'ty
1	WB1097	Wooden Case	1	48	UZ1077	Bush, 1077	1
2	YWA040A	Washer, 4φ	4	49		PB-1402-7	1
3	WD1144	Escutcheon	4	50		PB-1402-8	1
4	YJB40C14	Screw, M4x10	4	51		PB-1401-6	1
5	WT1044	Ventilation, 1044	1	52		PB-1401-3	1
6	WT1046	Ventilation, 1046	1	53	UB1074-2	Sub Panel	1
7		PB-1401-4	1	54	WQ5005	Fiber	1
8	UZ1295	Shaft, 1295	1	55	UW1151	Spacer	2
9	SP0080	SW, Push SDU4P TV-5 (power)	1	56	WE1113	Protector	2
10	UR1337	Bkt., 1337	1	57	WZ1188	Spacer	1
11	UD1156-2	Side Panel	1	58	WE1103	Protector	11
12		PB-1402-1	1	59	UU1042-1	Spring	11
13	UJ1102	Cover, 1102	1	60	WJ1166-2	Knob, Mold	3
14	UC1209-1	Rear Panel (J,A)	1	61	WD1141	Escutcheon	3
	UC1209-2	Rear Panel (AE)	1	62	WJ1165-1	Knob, Mold	6
	UC1209-3	Rear Panel (AK,EK)	1	63	WJ1165-2	Knob, Mold	1
15	AT5026A	Terminal, SP Black	4	64	WJ1166-1	Knob, Mold	1
	AT5026B	Terminal, SP Red	4	65	WG1020	Acryl, Pilot	1
16	UZ1244	Housing, LPS (J)	1	66	WD1140	Escutcheon	1
17	UZ1245	Terminal, LPS (J)	1	67	WD1145	Escutcheon	4
18	BU0033	Bush (AK,AZ)	1	68	WE1112	Protector	7
	BU0039	Bush (EG)	1	69	SPO090	Preheat	1
	BU0080	Bush (J)	1	70	AJ0014	Jack LJ264-1-7	1
19	BK0018	AC Cord (120V)	1	71	TD0232	LED (Orange)	1
	BK0022	AC Cord (220V)	1	72	AS0263	Socket, LED	2
	BK0023	AC Cord (240V)	1	73	TD0233	LED (Green)	1
	BK0048	AC Cord (J)	1	74	UH1038	Channel, 1038	1
20	AL0001	Lamp, BNB-2 (J)	1	75	UZ1299	Bkt., 1299	1
21	UJ1107	Cover, 1107 (E)	1	76	UU1043	Spring, 1043	1
22	AC0010	AS Socket MD-40 (E)	1	77	UZ1296	Shaft, 1296	1
	AC0055	AS Socket S-I6488 (J)	1	78	UZ1297	Bkt., 1297	1
23	AG0110	Terminal, GNC Lux-1260	1	79	UZ1298	Bkt., 1298	1
24		PB-1401-7	1	80	WC1037	Ornametn Plate	2
25		PB-1400-4	1	81	UW1153	Spacer	2
26	BE1088	Heat Pipe	1	82	WJ1164	Knob, Mold	3
27		PB-1401-1	1	83	WK1134	Knob, Metal	3
28	UH1056-1	Side Panel	1	84	WH1132	Knobset	3
29	CE1454	Cap, 50V 30,000uF	2	85	WH1133	Knobset	4
30	AS0258	PB Socket 18S	2	86	WK1135	Knob, Metal	1
31	AS0192	PB Socket 10S	1	87	WJ1163	Knob, Mold	1
32		PB-1400-2b	1	88	WA1242-3	Panel, Front	1
33		PB-1400-2a	1	89	WA1243	Panel	1
34		PB-1400-3	1	90	AT0147	1P Pin Jack UA0036	6
35	PT2591	Trans, Power P-2591(J)	1	91	WE1112	Protector	7
	PT2593	Trans, Power P-2593(E)	1	92	WN1024	Foot, Metal	4
36	UH1037	Channel Bar	1	93	WN1025	Felt, Foot	4
37		PB-1401-5 (0273)	1	94	YJB40C08	Screw, M4x14	4
38		PB-1402	1	95	UE1116	Bottom Plate	1
39		PB-1402-2	1	96	WJ1168	Knob, Mold	2
40		PB-1401-8	1	97		PB-1411	1
41		PB-1401	1	98	AS0264	Socket, LED	1
42		PB-1402-4	1	99	AS0265	Socket, LED	1
43		PB-1402-3	1	100	UR1334	Bkt.	1
44		PB-1401-2	1	101	UK1122	Plate, Shield	1
45		PB-1402-5	1	102		PB-1400	1
46	AL0070	Lamp	1	103	SZ0024	Cable, Remote (Function)	1
47		PB-1402-6	1	104	SZ0025	Cable, Remote (Cartridge)	1
48	UZ1077	Bush, 1077	1	Accessory			
49		PB-1402-7	1		ME0211	Owner's Manual (EX)	1
50		PB-1402-8	1		MA0151	Owner's Manual (J)	1

L-550

L-550

**Exploded View**

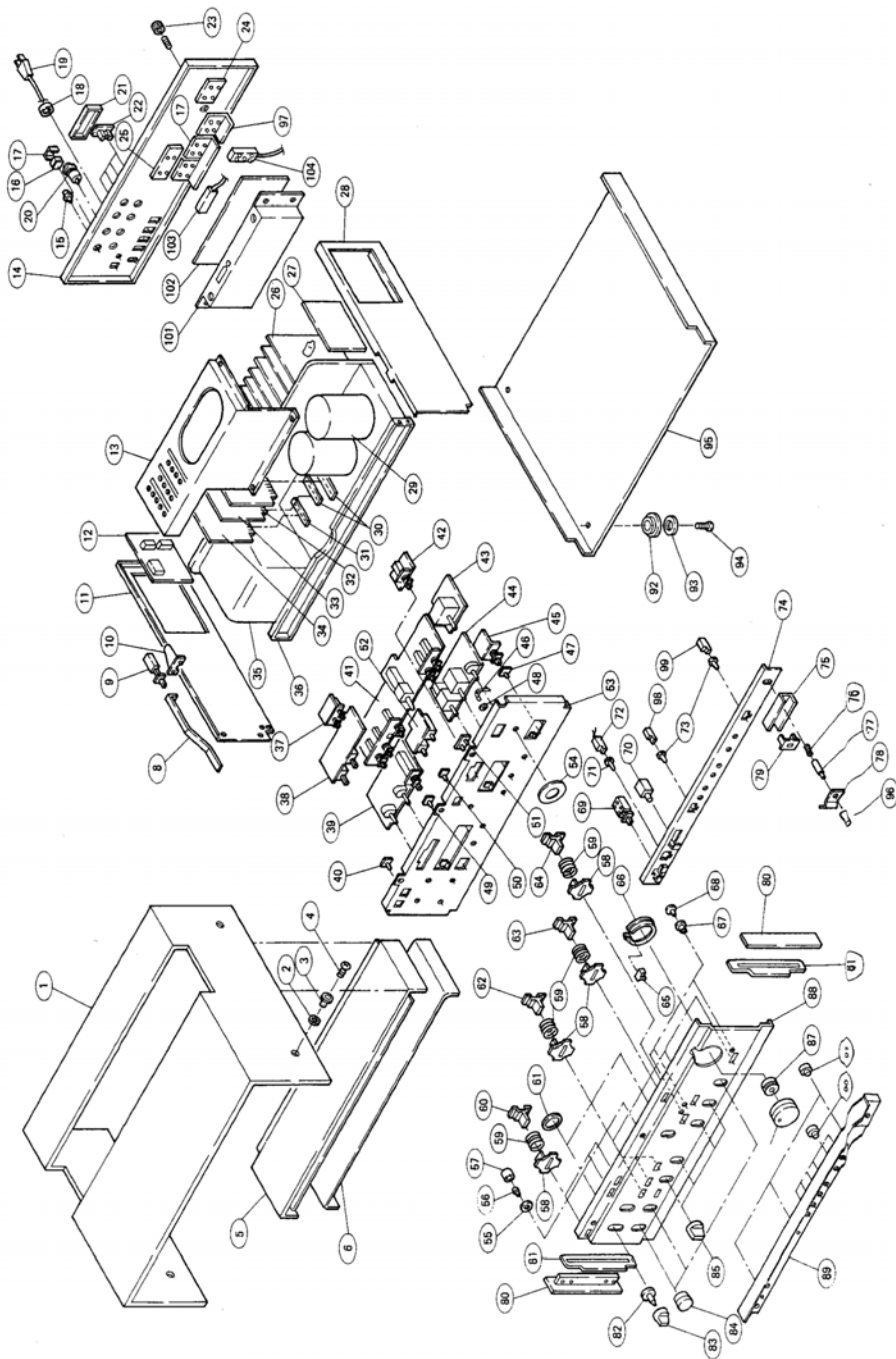

## L-550 調整手順

### 1) MCヘッドアンプ部定電圧電源部DC Off Setの調整

マッチング条件 Input Selector.....Phono Front  
Cartridge Selector.....MC 300-ohm  
Phono Input (Front).....Open

- (1) MCヘッドアンプ部 (PB-1400) に示すチェック端子W36 (AVR. +側) 及びW38 (AVR. -側)、W31 (L-ch出力) 及びW29 (R-ch出力) のそれぞれと対アース間にDC電圧計を接続する。
- (2) Power SwitchをONにし、W36、W38に接続した電圧計が、+10.25V、-10.25Vになる様PB-1400に示すVR102 (+側) 及VR103 (-側) にて調整する。

### 2) MCヘッドアンプ入力Off Set調整

- (1) カートリッジインピーダンススイッチを300-ohmの位置にする。  
ファンクションスイッチをPhono Frontにする。
- (2) Phono Frant入力端子に高感度DC電圧計を接続し、Powr Sw ON、2分後、+150 $\mu$ Vになる様VR101a (L-ch) VR101b (R-ch) により調整する。(PB-1400)

### 3) プリアンプ部定電圧電源の調整

- (1) PB-1400-1 に示すチェック端子W22 (+側) 及W17 (-側) と対アース間にDC電圧を接続する。
- (2) PB-1400-1 に示すVR201 (+側) 及VR202 (-側) にて+31.25V、-31.25Vになる様調整する。

### 4) イコライザー部DC Off Setの調整

Phono Input (Front) にショートピンを入れる。

- (1) PB-1401-1 に示すチェック端子P-2コネクターポストと対アース間にDC電圧計を接続する。  
※コネクタポストシルクNo1側→Lch、No3側→Rchとなっています。
- (2) PB-1400-1 に示すVR401a (Rch) 及VR401b (Lch) にてOVになる様調整する。

### 5) メイン部定電圧電源の調整

- (1) Volume Controlを最少にし各フィルタースイッチはOff又はディフェルトにしておく。
- (2) PB-1400-3 に示すチェック端子C312 (+側) 及C311 (-側) と対アース間にDC電圧計を接続する。
- (3) PB-1400-3 に示すVR301 (+側) 及VR302 (-側) にて+46.5V、-46.5Vになる様調整する。

### 6) メイン部DC Off Set及アイドリングの調整

- (1) PB-1403-2 に示すチェック端子TP (Lch) 及PB-1403-3 に示すチェック端子TP (Rch) と対アース間にDC電圧計を接続する。
- (2) PB-1400-2 (Lch、Rch、で2枚有ります。) で示すVR351にてOVになる様調整する。
- (3) PB-1403-2 に示すR814aの両端 (0.22 $\Omega$ Lch) 及PB-1403-3 に示すR814bの両端 (0.22 $\Omega$ Rch) にそれぞれDC電圧計を接続する。
- (4) PB-1403に示すVR801a (Lch) 及PB-1403-1 に示すVR801b (Rch) にて160mVになる様調整する。

- ※ プリヒーティング: Power SwitchをOFFの状態でのスイッチをONにするとプリヒーティングのインジケータが点灯し、他のインジケータが点灯せず又ファイナルのトランジスターへの電流だけがカットされ、その他は動作状態となっています。消費電力は約40W。

## Alignment Procedure

### 1. Alignment of MC Headamp. Regulator & DC Offset

Setting Conditions - Input Selector: Phono Front  
 Cartridge Selector: MC 300-ohm  
 Phono Input (Front): Open

- (1) Connect a DC voltmeter in between the ground and the test-points shown on MC Headamp. section (PB-1400), W36(AVR, positive) and W38(AVR, negative), and W31(L-CH output) and W29(R-CH output) respectively.
- (2) Press to switch Power Switch ON and adjust VR102(positive) and VR103(negative) shown on PB-1400 to make the DC voltmeter connected to W36 and W38 read +10.25V and -10.25V respectively.

### 2. Alignment of MC Headamp. Input Offset

- (1) Set Cartridge Impedance Selector at 300-ohm and Input Selector Button at Phono Front.
- (2) Connect a high sensitive DC voltmeter and press to switch Power Switch ON. After 2 minutes, adjust VR101a(L-CH) and VR101b(R-CH) on PB-1400 to make the voltmeter read +150uV.

### 3. Alignment of Preamp. Section Regulator

- (1) Connect a DC voltmeter in between the ground and the test-points shown on PB-1400-1, W22(positive) and W17(negative).
- (2) Adjust VR201(positive) and VR202(negative) shown on PB-1400-1 to make the voltmeter read +31.25V and -31.25V respectively.

### 4. Alignment of Equalizer Section DC Offset

Insert short pin-plugs into Phono-Front Input Jack.

- (1) Connect a DC voltmeter in between the ground and the test-point shown on PB-1401-1, P-2 connector post (No. 1 for L-CH, No. 3 for R-CH).
- (2) Adjust VR401a(R-CH) and VR401b(L-CH) shown on PB-1401-1 to make the voltmeter read 0V.

### 5. Alignment of Mainamp. Section Regulator

- (1) Turn Volume Control to the minimum and set each Filter Switch at OFF or Defeat position.
- (2) Connect a DC voltmeter in between the ground and the check-points shown on PB-1400-3, C312(positive) and C311(negative).
- (3) Adjust VR301(positive) and VR302(negative) to make the voltmeter read +46.5V and -46.5V respectively.

### 6. Alignment of Mainamp. section DC Offset and Idling Current

- (1) Connect a DC voltmeter in between the ground and the check-points, TP(L-CH) shown on PB-1403-2 and TP(R-CH) on PB-1403-3.
- (2) Adjust VR351 shown on PB-1400-2 (2 pcs. for L-CH and R-CH) to make the voltmeter read 0V.
- (3) Connect a DC voltmeter to each both ends of R814a(0.22-Ohm, L-CH) shown on PB-1403-2 and R814b(0.22-Ohm, R-CH).
- (4) Adjust VR801a(L-CH) shown on PB-1403 and VR801b(R-CH) on PB-1403-1 to make the voltmeter read 160mV.

Pre-Heating Switch: When this switch is switched ON with Power Switch OFF, Pre-Heating Indicator lights up, while other indicators would not light up. Current only to the final transistors is cut off and others are kept in operation.

## Adjustment Locations

L-550

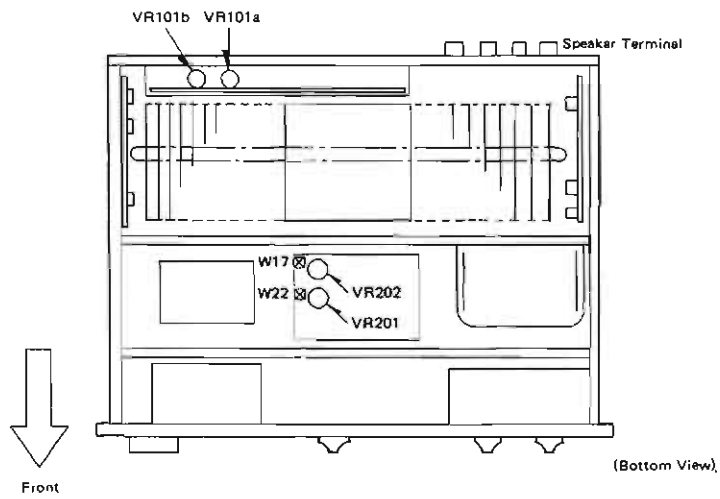
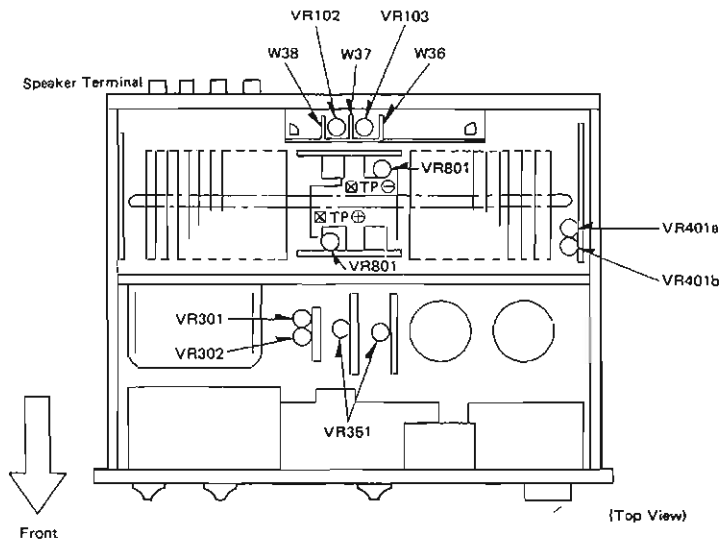



## PB1399 Parts List

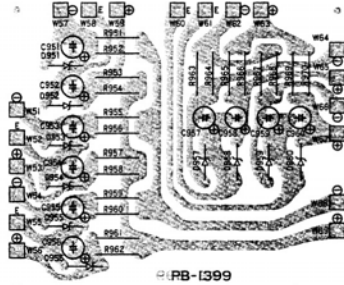

Symbol No.	Stock No.	Description
(Zener, Diode)		
D951	TD0043	WZ-130
D952	TD0043	WZ-130
D953	TD0043	WZ-130
D954	TD0043	WZ-130
D955	TD0043	WZ-130
D956	TD0043	WZ-130
D957	TD0043	WZ-130
D958	TD0043	WZ-130
D959	TD0043	WZ-130
D960	TD0043	WZ-130
(Capacitor)		
C951	CE0075	22uF 16V E1

Symbol No.	Stock No.	Description
C952	CE0075	22uF 16V E1
C953	CE0075	22uF 16V E1
C954	CE0075	22uF 16V E1
C955	CE0075	22uF 16V E1
C956	CE0075	22uF 16V E1
C957	CE0075	22uF 16V E1
C958	CE0075	22uF 16V E1
C959	CE0075	22uF 16V E1
C960	CE0075	22uF 16V E1
	CK0145	0.022uF 50V Ce
(Resistor)		
R951	RD2600	5.6K 1/2W Rd
R952	RD2602	6.8K 1/2W Rd
R953	RD2600	5.6K 1/2W Rd
R954	RD2602	6.8K 1/2W Rd
R955	RD2600	5.6K 1/2W Rd
R956	RD2602	6.8K 1/2W Rd
R957	RD2600	5.6K 1/2W Rd
R958	RD2602	6.8K 1/2W Rd
R959	RD2600	5.6K 1/2W Rd
R960	RD2602	6.8K 1/2W Rd
R961	RD2600	5.6K 1/2W Rd
R962	RD2602	6.8K 1/2W Rd
R963	RD2600	5.6K 1/2W Rd
R964	RD2600	5.6K 1/2W Rd
R965	RD2600	5.6K 1/2W Rd
R966	RD2600	5.6K 1/2W Rd
R967	RD2600	5.6K 1/2W Rd
R968	RD2600	5.6K 1/2W Rd
R969	RD2600	5.6K 1/2W Rd
R970	RD2600	5.6K 1/2W Rd

L-550

## PB1400 Parts List

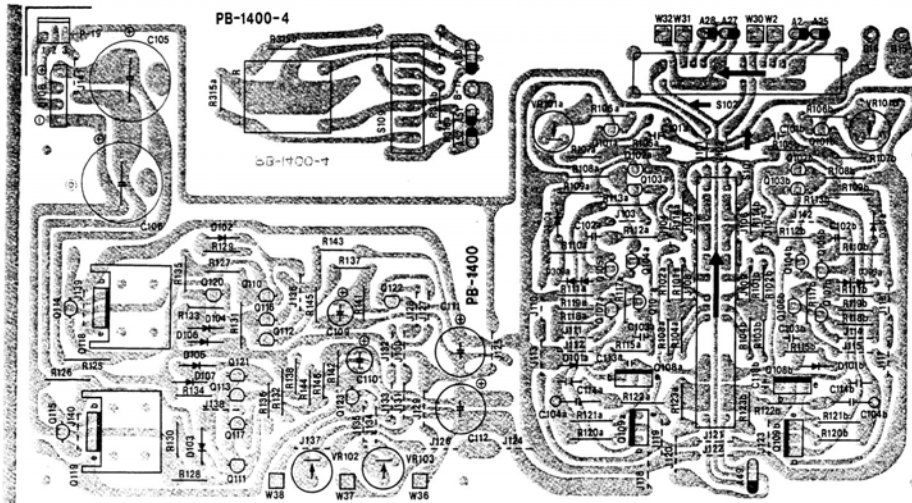

Symbol No.	Stock No.	Description
(Slide Switch)		
S101	SS0146	SSR266N (Cartridge)
S102	SS0145	SSR24601D (Function)
(Semi-Fixed Resistor)		
VR101a,b	RT0125	CR29R 2.2KB
VR102	RT0124	SR29R 2.2KB
VR103	RT0124	SR29R 2.2KB
(Transistor, FET)		
Q101a,b	TR5004	2SC2240-BL
Q102a,b	TR0372	2SA1114-F
Q103a,b	TR0372	2SA1114-F
Q104a,b	TR5004	2SC2240
Q105a,b	TR5004	2SC2240
Q106a,b	TR5005	2SA970
Q107a,b	TR0198	2SC1815
Q108a,b	TR0121	2SC1626
Q109a,b	TR0122	2SA816
Q110	TR0087	2SA1015
Q111	TR0198	2SC1815
Q112	TR0198	2SC1815
Q113	TR0087	2SA1015
Q114	TR0198	2SC1815
Q115	TR0087	2SA1015
Q116	TR0198	2SC1815
Q117	TR0087	2SA1015
Q118	TR0190	2SC1624
Q119	TR0188	2SA814
Q120	TR0198	2SC1815
Q121	TR0087	2SA1015
Q122	TF0033	2SK30A-TM
Q123	TF0033	2SK30A-TM
(Diode, Varistor)		
D101a,b	TD0227T	1SS41
D102	TD0227T	1SS41
D103	TD0227T	1SS41
D104	TD0227T	1SS41
D105	TD0227T	1SS41
D106	TD0227T	1SS41
D107	TD0227T	1SS41
D108	TD0137	SLVB10
D309a,b	TV0021	KB465 Varistor
D310a,b	TV0033	KB365 Varistor
(Capacitor)		
C101a,b	CM0175	1000pF 500V M1
C102a,b	CM0068	100pF 50V M1
C103a,b	CM0072	150pF 50V M1
C104a,b	CM0697	1uF 100V F1
C105	CE1455	3300uF 25V E1
C106	CE1455	3300uF 25V E1
C109	CE1977	4.7uF 50V E1

Symbol No.	Stock No.	Description
C110	CE1977	4.7uF 50V E1
C111	CE0075	22uF 16V E1
C112	CE0075	22uF 16V E1
C113a,b	CM0060	47pF 50V M1
C114a,b	CM0172	680pF 500V M1
	CM0153	22pF 500V M1
(Resistor)		
R101a,b	RB0348T	100 Rd
R102a,b	RB0416T	68K Rd
R103a,b	RB0352T	150 Rd
R104a,b	RB0340T	47 Rd
R105a,b	RB0358T	270 Rd
R106a,b	RD2572	390 1/2W Rd
R107a,b	RB0408T	33K Rd
R108a,b	RD2578	680 1/2W Rd
R109a,b	RD2570	330 1/2W Rd
R110a,b	RD2570	330 1/2W Rd
R111a,b	RB0400T	15K Rd
R112a,b	RB0340T	47 Rd
R113a,b	RD2550	47 1/2W Rd
R114a,b	RB0308	2.2 Rd
R115a,b	RB0360T	330 Rd
R117a,b	RB0360T	330 Rd
R118a,b	RB0370T	820 Rd
R119a,b	RB0362T	390 Rd
R120a,b	RS2501L	10 1/2W Rf
R121a,b	RS2501L	10 1/2W Rf
R122a,b	RD2546	33 1/2W Rd
R123a,b	RB0444T	1M Rd
R125	RD2632	120K 1/2W Rd
R126	RD2632	120K 1/2W Rd
R127	RB0360T	330 Rd
R128	RB0360T	330 Rd
R129	RB0360T	330 Rd
R130	RB0360T	330 Rd
R131	RD2610	15K 1/2W Rd
R132	RD2608	12K 1/2W Rd
R133	RB0346T	82 Rd
R134	RB0346T	82 Rd
R135	RB0390T	5.6K Rd
R136	RB0390T	5.6K Rd
R137	RB0336T	33 Rd
R138	RB0336T	33 Rd
R141	RB0394T	8.2K Rd
R142	RB0394T	8.2K Rd
R143	RD0458	4.7K 1/3W Rd
R144	RD0458	4.7K 1/3W Rd
R145	RD0458	4.7K 1/3W Rd
R146	RD0458	4.7K 1/3W Rd

## PB1400-1 Parts List

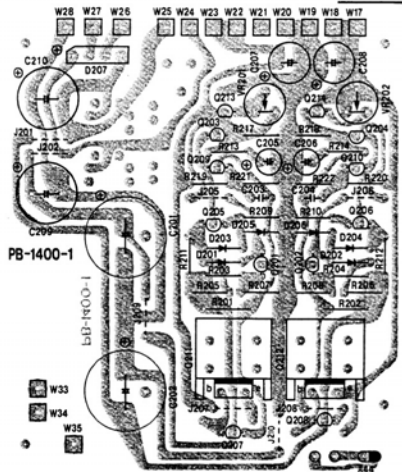

Symbol No.	Stock No.	Description
<b>(Transistor, FET)</b>		
Q201	TR0087	2SA1015
Q202	TR0198	2SC1815
Q203	TR5004	2SC2240
Q204	TR5005	2SA970
Q205	TR0198	2SC1815
Q206	TR0087	2SA1015
Q207	TR0198	2SC1815
Q208	TR0087	2SA1015
Q209	TR5004	2SC2240
Q210	TR5005	2SA970
Q211	TR0190	2SC1624
Q212	TR0188	2SA814
Q213	TF0033	2SK30A-TM
Q214	TF0033	2SK30A-TM
<b>(Diode)</b>		
D201	TD0227T	1SS41

Symbol No.	Stock No.	Description
D202	TD0227T	1SS41
D203	TD0227T	1SS41
D204	TD0227T	1SS41
D205	TD0227T	1SS41
D206	TD0227T	1SS41
D207	TD0139	S1VB20

<b>(Capacitor)</b>			
C201	CE1909	1000uF	50V E1
C202	CE1909	1000uF	50V E1
C203	CM0056	33pF	50V Mi
C204	CM0056	33pF	50V Mi
C205	CE1977	4.7uF	50V E1
C206	CE1977	4.7uF	50V E1
C207	CE0100	10uF	50V E1
C208	CE0100	10uF	50V E1
C209	CE2048	470uF	50V E1
C210	CE2048	470uF	50V E1
	CK0145	0.022uF	50V Ce

<b>(Semi-Fixed Resistor)</b>		
VR201	RT0100	SR19R 2.2KB
VR202	RT0100	SR19R 2.2KB

<b>(Resistor)</b>				
R201	RD2632	120K	1/2W	Rd
R202	RD2632	120K	1/2W	Rd
R203	RB0360T	330		Rd
R204	RB0360T	330		Rd
R205	RB0360T	330		Rd
R206	RB0360T	330		Rd
R207	RB0406T	27K		Rd
R208	RB0402T	18K		Rd
R209	RB0346T	82		Rd
R210	RB0346T	82		Rd
R211	RB0408T	33K		Rd
R212	RB0408T	33K		Rd
R213	RB0336T	33		Rd
R214	RB0336T	33		Rd
R217	RB0392T	6.8K		Rd
R218	RB0392T	6.8K		Rd
R219	RD0450	22K	1/3W	Rd
R220	RD0450	22K	1/3W	Rd
R221	RD0460	3.3K	1/3W	Rd
R222	RD0460	3.3K	1/3W	Rd

## PB1400-2 Parts List

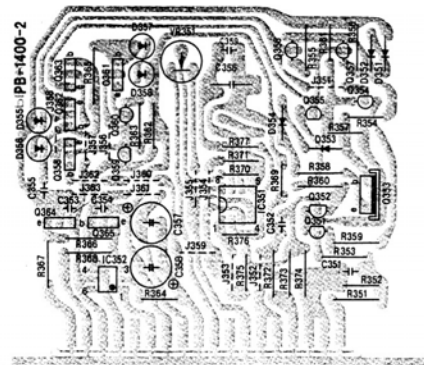

Symbol No.	Stock No.	Description
<b>(Semi-Fixed Resistor)</b>		
VR351a,b	RT0017	SR29R 47KB
<b>(IC)</b>		
IC351a,b	TC5040	NJM082D
IC352a,b	TC0199	NJL5160D
<b>(Transistor, FET)</b>		
Q351,2	TF0032	2SK146-BL
Q353a,b	TR0121	2SC1626
Q354a,b	TR0236	2SC2229
Q355a,b	TR0236	2SC2229
Q356a,b	TR0087	2SA1015

L-550

MC-Service

Symbol No.	Stock No.	Description
Q357a,b	TR0087	2SA1015
Q358a,b	TR0369	2SA1144
Q359a,b	TR0198	2SC1815
Q360a,b	TR0198	2SC1815
Q361a,b	TR0360	2SC2704
Q362a,b	TR0369	2SA1144
Q363a,b	TR0369	2SA1144
Q364a,b	TR0318	2SC1904-BV
Q365a,b	TR0342	2SA899-BV
	TF0018	2SK147-BK
<b>(Diode,Varistor)</b>		
D351a,b	TD0227T	1SS41
D352a,b	TD0227T	1SS41
D353a,b	TD0227T	1SS41
D354a,b	TD0227T	1SS41
D355a,b	TV0033	KB365 Varistor
D356a,b	TV0033	KB365 Varistor
D357a,b	TV0033	KB365 Varistor
D358a,b	TV0033	KB365 Varistor
<b>(Capacitor)</b>		
C351a,b	CM0060	47pF 50V Mi
C352a,b	CM0050	10pF 50V Mi
C353a,b	CM0164	5pF 500V Mi
C354a,b	CM0164	5pF 500V Mi
C356a,b	CE5050	2.2uF 50V EI
C357a,b	CE0107	47uF 63V EI
C358a,b	CE0107	47uF 63V EI
C359a,b	CM0172	680pF 500V Mi

Symbol No.	Stock No.	Description
<b>(Resistor)</b>		
R351a,b	RD2574	470 1/2W Rd
R352a,b	RB0442T	820K Rd
R353a,b	RD2558	100 1/2W Rd
R354a,b	RB0416T	68K Rd
R355a,b	RS1445	47 1/3W Rf
R356a,b	RS1445	47 1/3W Rf
R357a,b	RB0408T	33K Rd
R358a,b	RS1445	47 1/3W Rf
R359a,b	RS1453	100 1/3W Rf
R360a,b	RS1453	100 1/3W Rf
R361a,b	RB0424T	150K Rd
R362a,b	RS1451	82 1/3W Rf
R363a,b	RS1451	82 1/3W Rf
R364a,b	RB0384T	3.3K Rd
R365a,b	RB0418	82K Rd
R366a,b	RS1473	560 1/3W Rf
R367a,b	RS1453	100 1/3W Rf
R368a,b	RS1453	100 1/3W Rf
R369a,b	RB0432T	330K Rd
R370a,b	RB0396T	10K Rd
R371a,b	RB0364T	470 Rd
R372a,b	RD2600	5.6K 1/2W Rd
R373a,b	RD2600	5.6K 1/2W Rd
R374a,b	RD0350	120 Rd
R375a,b	RB0404T	22K Rd
R376a,b	RB0398T	12K Rd
R377a,b	RB0398T	12K Rd

**PB1400-3 Parts List**

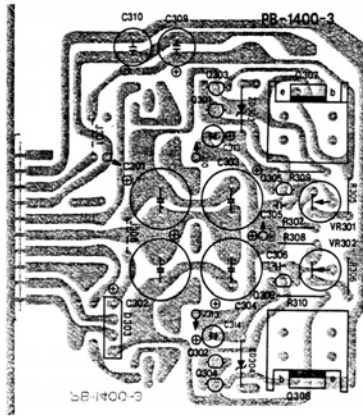

Symbol No.	Stock No.	Description
<b>(Semi-Fixed Resistor)</b>		
VR301	RT0026	SR29R 4.7KB
VR302	RT0026	SR29R 4.7KB
<b>(Transistor,FET)</b>		
Q301	TF0030	2SK117Y
Q302	TF0030	2SK117Y
Q303	TR5004	2SC2240
Q304	TR5005	2SA970

*MC-Service*

Symbol No.	Stock No.	Description
Q305	TR5004	2SC2240
Q306	TR5005	2SA970
Q307	TR0190	2SC1624
Q308	TR0188	2SA814
<b>(Diode)</b>		
D303	TD0139	S1VB20
<b>(Zener,Diode)</b>		
ZD303	TD0025	WZ090
ZD304	TD0025	WZ090
<b>(Capacitor)</b>		
C301	CE2077	220uF 100V EI
C302	CE2077	220uF 100V EI
C303	CE2077	220uF 100V EI
C304	CE2077	220uF 100V EI
C305	CM0056	33pF 50V EI
C306	CM0056	33pF 50V EI
C309	CE0147	10uF 63V EI
C310	CE0147	10uF 63V EI
C313	CE1948	22uF 16V EI
C314	CE1948	22uF 16V EI
<b>(Resistor)</b>		
R305	RD0449	27K 1/3W Id
R306	RD0449	27K 1/3W Id
R307	RD0456	6.8K 1/3W Id
R308	RD0456	6.8K 1/3W Id
R309	RD2606	10K 1/2W Id
R310	RD2606	10K 1/2W Id

## PB1400-4 Parts List

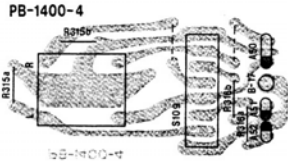

Symbol No.	Stock No.	Description
(4P Pin Jack)		
	AT0150A	T5757BA
(Slide Switch)		
S109	SS0135	SSB04202 (Signal Processing)
(Resistor)		
R315a,b	RB0412T	47K Rd

L-550

## PB1401 Parts List

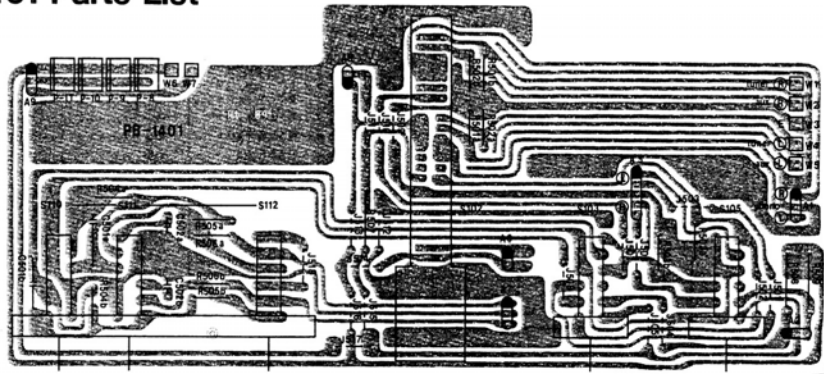

Symbol No.	Stock No.	Description
(Switch)		
S102	SR0165	SRZW6SA (Function)
S103	SP0270	SUL121A (Monitor)
S105	SP0270	SUL121A (Recording)
S110-112	SP0265	SUL331A (Subsonic, High cut, Mono)
(Capacitor)		
C501a,b	CQ0610	0.33uF 100V Fi
C502a,b	CQ0018T	0.0056uF 50V My
(Resistor)		
R501a,b	RB0444T	1M Rd

Symbol No.	Stock No.	Description
R502a,b	RB0444T	1M Rd
R503a,b	RB0444T	1M Rd
R504a,b	RB0444T	1M Rd
R505a,b	RB0380T	2.2K Rd
R506a,b	RB0384T	3.3K Rd
R507	RS2746LA	560 1W Rf
R508	RS2746LA	560 1W Rf
R509	RS2746LA	560 1W Rf
	RB0444	1M Rd

## PB1401-1 Parts List

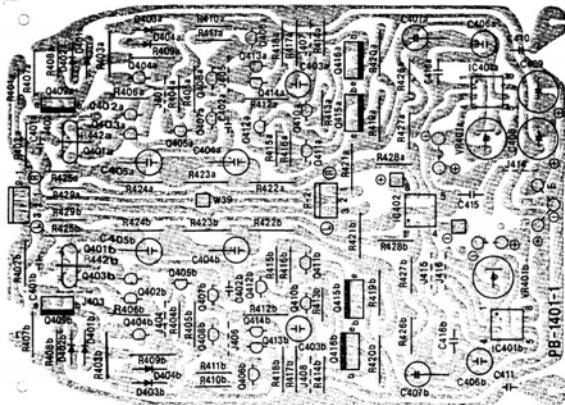

Symbol No.	Stock No.	Description
(Semi-Fixed Resistor)		
VR401a,b	RT0024	CR19R 10KB
(Capacitor)		
C401a,b	CM0152	10pF 100V Mi
C402a,b	CM0056	33pF 50V Mi
C403a,b	CQ3013	1000pF 120V St
C404a,b	CQ3025	10000pF 120V St
C405a,b	CQ3018	2700pF 120V St
C406a,b	CE1975B	2.2uF 50V BP E1
C407a,b	CQ0693	0.22uF 100V Fi
C408	CE1981	47uF 50V E1
C409	CE1981	47uF 50V E1
C410	CM0068	100pF 50V Mi
C411	CM0068	100pF 50V Mi
C415	CQ3018	2700pF 120V St
C416a,b	CM0149	330pF 50V Mi

Symbol No.	Stock No.	Description
<b>(IC)</b>		
IC401a,b	TC0197	TL-071CP
IC402	TC0025	NJM4558D-D
<b>(Transistor, FET)</b>		
Q401a,b	TF0032	2SK146-BL
Q402a,b	TR0198	2SC1845
Q403a,b	TR0198	2SC1845
Q404a,b	TR0320	2SA992
Q405a,b	TR0320	2SA992
Q406a,b	TR0323	2SC1815
Q407a,b	TR0332	2SA857-V
Q408a,b	TR0237	2SA949
Q409a,b	TR0132	2SD414
Q410a,b	TR0323	2SC1815
Q411a,b	TR0198	2SC1815
Q412a,b	TR0331	2SC1438-V
Q413a,b	TR0198	2SC1815
Q414a,b	TR0198	2SC1815
Q415a,b	TR0209	2SC2238
Q416a,b	TR0210	2SA968
	TF0018	2SK147-BL
<b>(Diode)</b>		
D401a,b	TD0227T	1SS41
D402a,b	TD0227T	1SS41
D403a,b	TD0227T	1SS41
D404a,b	TD0227T	1SS41
<b>(Resistor)</b>		
R401a,b	RB0426T	180K Rd
R402a,b	RS2534	10 1/2W Rf

Symbol No.	Stock No.	Description
R403a,b	RS1445	47 1/3W Rf
R404a,b	RB0420T	100K Rd
R405a,b	RS1445	47 1/3W Rf
R406a,b	RB0408T	33K Rd
R407a,b	RS1445	47 1/3W Rf
R408a,b	RB0370T	820 Rd
R409a,b	RD2614	22K 1/2W Rd
R410a,b	RB0386	3.9K Rd
R411a,b	RB0372T	1K Rd
R412a,b	RD2612	18K 1/2W Rd
R413a,b	RB0386	3.9K Rd
R414a,b	RB0372T	1K Rd
R415a,b	RB0378T	1.8K Rd
R416a,b	RB0376T	1.5K Rd
R417a,b	RS1451	82 1/2W Rf
R418a,b	RS1451	82 1/2W Rf
R419a,b	RS1435	18 1/3W Rf
R420a,b	RS1435	18 1/3W Rf
R421a,b	RD2568	270 1/2W Rd
R422a,b	RD2573	430 1/2W Rd
R423a,b	RD2642	330K 1/2W Rd
R424a,b	RD2616	27K 1/2W Rd
R425a,b	RB0358T	270 Rd
R426a,b	RB0442T	820K Rd
R427a,b	RB0394T	8.2K Rd
R428a,b	RB0394T	8.2K Rd
R429a,b	RB0398T	12K Rd
R442a,b	RB0354T	180 Rd
	RD2166	3.3M 1/3W Rd

### PB1401-2 Parts List

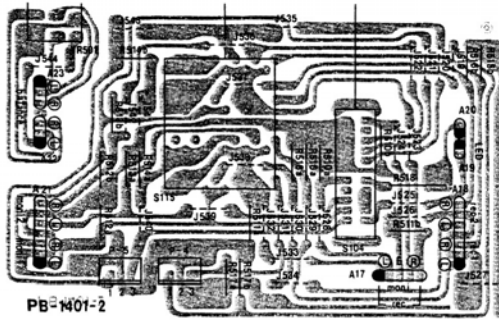

Symbol No.	Stock No.	Description
<b>(Rotary Switch)</b>		
S104	SR0169	SR2W43N (Tape)
S115	SR0170	SPJ4085 (Dubbing)
<b>(Variable Resistor)</b>		
VR501	RV0292	250KMN (Balance)
<b>(Resistor)</b>		
R510a,b	RB0444T	1M Rd
R511a,b	RB0444T	1M Rd
R512a,b	RB0444T	1M Rd
R513a,b	RB0444T	1M Rd
R514a,b	RB0444T	1M Rd
R515a,b	RB0444T	1M Rd
R516a,b	RB0444T	1M Rd
R517a,b	RB0444T	1M Rd
R518	RS2746LA	560 1W Rf

### PB1401-3 Parts List

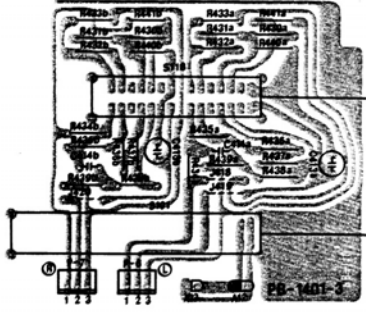

Symbol No.	Stock No.	Description
(Rotary Switch)		
S101	SR0166	SRZ2M (Cartridge)
S118	SR0171	SRZW45S (liner Equalized)
(Capacitor)		
C413a,b	CQ1446	7500pF 50V St
C414a,b	CQ1337	0.22uF 50V My
(Resistor)		
R430a,b	RB0400T	15K Rd
R431a,b	RB0444T	1M Rd
R432a,b	RB0400T	15K Rd
R433a,b	RB0382T	2.7K Rd
R434a,b	RB0386T	3.9K Rd
R435a,b	RB0394T	8.2K Rd
R436a,b	RB0444T	1M Rd
R437a,b	RB0394T	8.2K Rd
R438a,b	RB0382T	2.7K Rd
R439a,b	RB0386T	3.9K Rd
R440a,b	RB0460	4.7K Rd
R441a,b	RB0381T	2.4K Rd

### PB1401-4 Parts List

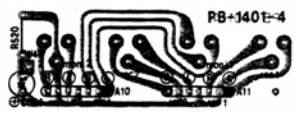

Symbol No.	Stock No.	Description
(4P Pin Jack)		
	AT0151A	T5754 5A
(Resistor)		
R520	RB0348	100 Rd
(Capacitor)		
C504	CE0074T	10uF 16V E1

### PB1401-5 Parts List

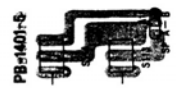

Symbol No.	Stock No.	Description
(Push Switch)		
S113-114	SP0273	SUF23 (Speaker)

### PB1401-6 Parts List



Symbol No.	Stock No.	Description
(LED)		
D407	TD0233	EBG5534S grn.(Monitor)
D408	TD0232	EAA5534S org.(Record)

### PB1401-7 Parts List



Symbol No.	Stock No.	Description
(4P Pin Jack)		
	AT0151A	T5754-BA
(Capacitor)		
C503	CE0074T	10uF 16V E1
(Resistor)		
R519	RB0348	100 Rd

L-550

### PB1401-8 Parts List



Symbol No.	Stock No.	Description
(LED)		
D409	TD0232	EAA5534S org.(warm-up)

### PB1402 Parts List

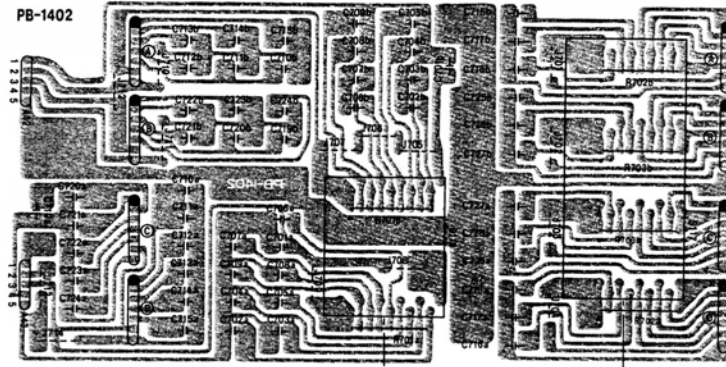

Symbol No.	Stock No.	Description
(Rotary Switch)		
S116	SR0167	SRJ2029(Treble Turnover)
S117	SR0168	SRJ4049(Bass Turnover)
(Capacitor)		
C701a,b	CQ0027T	0.0068uF 50V My
C702a,b	CQ0021T	0.0033uF 50V My
C703a,b	CQ0017T	0.0082uF 50V My
C704a,b	CQ0014T	0.015uF 50V My
C705a,b	CQ0013T	0.022uF 50V My
C706a,b	CQ1319T	0.033uF 50V My
C707a,b	CQ0008T	0.056uF 50V My
C708a,b	CQ0006T	0.082uF 50V My
C709a,b	CQ0005T	0.14uF 50V My
C710a,b	CQ1334	1uF 50V My
C711a,b	CQ2253F	0.22uF 50V My
C712a,b	CQ1344	0.82uF 50V My
C713a,b	CQ1339	0.56uF 50V My

Symbol No.	Stock No.	Description
C714a,b	CQ2257	0.39uF 50V My
C715a,b	CQ2253F	0.22uF 50V My
C716a,b	CQ2251F	0.15uF 50V My
C717a,b	CQ0006T	0.082uF 50V My
C718a,b	CQ1319T	0.033uF 50V My
C719a,b	CQ2253F	0.22uF 50V My
C720a,b	CQ1334	1uF 50V My
C721a,b	CQ2253F	0.22uF 50V My
C722a,b	CQ1344	0.82uF 50V My
C723a,b	CQ1339	0.56uF 50V My
C725a,b	CQ2251F	0.15uF 50V My
C726a,b	CQ0006T	0.082uF 50V My
C727a,b	CQ1319T	0.033uF 50V My
(Resistor)		
R701a,b	RK1001	1M R <sub>Ω</sub>
R702a,b	RK1001	1M R <sub>Ω</sub>
R703a,b	RK1001	1M R <sub>Ω</sub>

MC-Service



# PB1402-1 Parts List

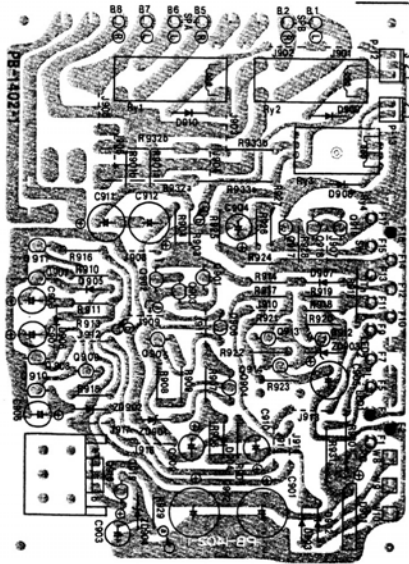

Symbol No.	Stock No.	Description
<b>(Relay)</b>		
RY1	AY1021	VB12MC
RY2	AY1021	VB12MC
RY3	AY0027	FRL-644D12/2AS
<b>(Transistor, FET)</b>		
Q901	TRO029	2SC945
Q902	TRO029	2SC945
Q903	TRO043	2SA733
Q904	TRO029	2SC945
Q905	TRO008	2SA562
Q907	TRO029	2SC945
Q908	TRO029	2SC945
Q909	TRO361	2SC2878
Q910	TRO361	2SC2878
Q911	TRO361	2SC2878
Q913	TRO029	2SC945
Q914	TF0030	2SK117Y
Q916	TR5012	2SD880
Q917	TRO361	2SC2878
Q918	TRO029	2SC945
Q919	TRO361	2SC2878
<b>(Diode)</b>		
D901	TD0137	S1VB10
D902	TD0002	1N4002
D903	TD0002	1N4002
D904	TD0227T	1SS41

Symbol No.	Stock No.	Description
D905	TD0227T	1SS41
D906	TD0227T	1SS41
D907	TD0227T	1SS41
D908	TD0002	1N4002
D909	TD0002	1N4002
D910	TD0002	1N4002
<b>(Zener Diode)</b>		
ZD901	TD0044T	WZ052
ZD902	TD0024T	WZ081
ZD903	TD0044T	WZ052
<b>(Capacitor)</b>		
C901	CE1735	470uF 25v E1
C902	CE1735	470uF 25V E1
C903	CE1722	220uF 16V E1
C904	CE1718	22uF 16V E1
C905	CE1722	220uF 16V E1
C907	CE1754T	10uF 50V E1
C908	CE1754T	10uF 50V E1
C909	CE1718	22uF 16V E1
C910	CE1751T	2.2uF 50V E1
C911	CE1721T	100uF 16V E1
C912	CE1722	220uF 16V E1
<b>(Resistor)</b>		
R901a,b	RB0404T	22K Rd
R903	RB0396T	10K Rd
R904	RB0394T	8.2K Rd
R905	RB0384T	3.3K Rd
R906	RB0438T	560K Rd
R907	RB0374T	1.2K Rd
R908	RB0396T	10K Rd
R909	RB0380T	2.2K Rd
R910	RB0372T	1K Rd
R911	RB0412T	47K Rd
R912	RS2746LA	560 1W Rf
R913	RB0412T	47K Rd
R914	RB0408T	33K Rd
R915	RB0396T	10K Rd
R916	RB0396T	10K Rd
R917	RB0388T	4.7K Rd
R921	RB0378T	1.8K Rd
R922	RB0420T	100K Rd
R923	RB0454	2.7M Rd
R924	RB0394T	8.2K Rd
R925	RB0374T	1.2K Rd
R926	RB0420T	100K Rd
R927	RB0336T	33 Rd
R928	RB0392T	6.8K Rd
R929	RS1859	270 Rf
R930	RS2503L	18 1/2W Rf
R931	RS2746LA	560 1W Rf
R932a,b	RS2953L	180 2W Rf
R933a,b	RS2953L	180 2W Rf
	RB0408	33K Rd
	RB0380	2.2K Rd
	RB0458	3.9M Rd

L-550

MC-Service

L-550

### PB1402-2 Parts List

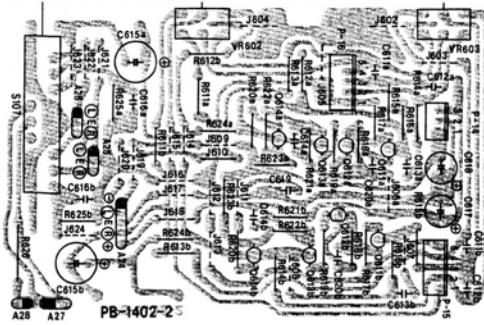

Symbol No.	Stock No.	Description
(Push Switch)		
S107	SP0263	SUL122A (Tone In)
(Variable Resistor)		
VR602	RV0291	5KBx2 (Treble)
VR603	RV0291	5KBx2 (Bass)
(Transistor, FET)		
Q611a,b	TF0028	2SK170-BL Pair
Q612a,b	TR0198	2SC1815
Q613a,b	TR0087	2SA1015
Q614a,b	TR0236	2SC2229

Symbol No.	Stock No.	Description
(Capacitor)		
C611a,b	CQ0006T	0.082uF 50V My
C612a,b	CQ0006T	0.082uF 50V My
C613a,b	CM0068	100pF 50V Mi
C614a,b	CQ0016T	0.01uF 50V My
C615a,b	CE1975	2.2uF 50V E1
C616a,b	CM0068	100pF 50V Mi
C617	CE1977	4.7uF 50V E1
C618	CE1977	4.7uF 50V E1
C619	CQ3063	47000pF Pp
	CK0145	0.022uF 50V Ce
(Resistor)		
R611a,b	RB0368T	680 Rd
R612a,b	RB0368T	680 Rd
R613a,b	RB0380T	2.2K Rd
R614a,b	RB0380T	2.2K Rd
R615a,b	RB0348T	100 Rd
R616a,b	RB0452T	2.2M Rd
R617a,b	RB0356T	220 Rd
R618a,b	RB0402T	18K Rd
R619a,b	RB0358T	270 Rd
R620a,b	RS1849	100 Rf
R621a,b	RB0404T	22K Rd
R622a,b	RB0410T	39K Rd
R623a,b	RB0374T	1.2K Rd
R624a,b	RB0348T	100 Rd
R625a,b	RB0432T	330K Rd
R626	RS2746LA	560 1W Rf

### PB1402-3 Parts List

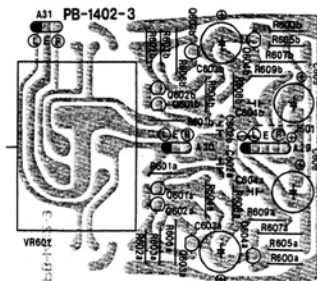

Symbol No.	Stock No.	Description
(Variable Resistor)		
VR601	RV0290	50Kx2 (Volume)
(Transistor, FET)		
Q601a,b	TF0028	2SK170-BL Pair
Q602a,b	TR0198	2SC1815

Symbol No.	Stock No.	Description
Q603a,b	TR0237	2SA949
Q604a,b	TR0236	2SC2229
(Capacitor)		
C602a,b	CM0060	47uF 50V MI
C603a,b	CE1978	10uF 50V E1
C604a,b	CQ1401	1000pF 50V St
C605	CE1977	4.7uF 50V E1
C606	CE1977	4.7uF 50V E1
(Resistor)		
R600a,b	RB0414T	56K Rd
R601a,b	RB0380T	2.2K Rd
R602a,b	RB0374T	1.2K Rd
R603a,b	RB0432T	330K Rd
R604a,b	RB0408T	33K Rd
R605a,b	RB0374T	1.2K Rd
R606a,b	RS1441	33 1/3W Rf
R607a,b	RS1449	68 1/3W Rf
R608a,b	RB0432T	330K Rd
R609a,b	RB0344T	68 Rd

**PB1402-4 Parts List**

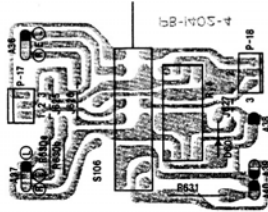

PB-1402-4

Symbol No.	Stock No.	Description	
(Push Switch)			
S106	SP0268	SUF12 (Phono Straight)	
(Relay)			
RY4	AY0027	FRL-644D12/2AS	
(Diode)			
D601	TD0002	1N4002	
(Resistor)			
R603a,b	RB0444T	1M	Rd
R631	RS2746LA	560	1W Rf

**PB1402-5 Parts List**

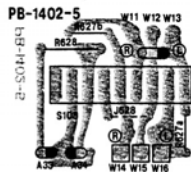

PB-1402-5

Symbol No.	Stock No.	Description	
(Push Switch)			
S108	SP0266	SUL121A (Signal Off)	
(Resistor)			
R627a,b	RB0414T	56K	Rd
R628	RS2746LA	560	1W Rf

**PB1402-6 Parts List**



Symbol No.	Stock No.	Description
(LED)		
D604	TD0232	EAA5534S org.(Signal Off)

**PB1402-7 Parts List**



Symbol No.	Stock No.	Description
(LED)		
D603	TD0232	EAA5534S org.(Tone In)

**PB1402-8 Parts List**



Symbol No.	Stock No.	Description
(LED)		
D602	TD0233	EBC5534S grn.(Phono Straight)

**PB1403/1403-1 Parts List**

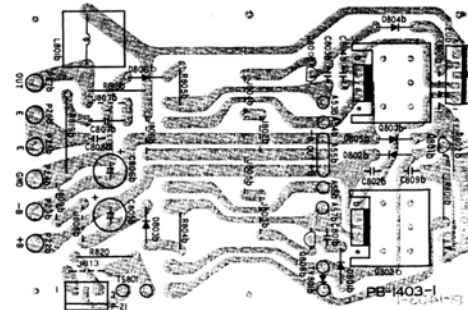
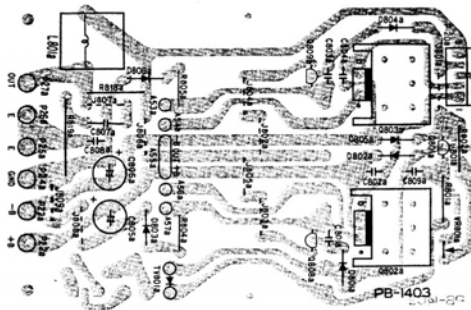

L-550

Symbol No.	Stock No.	Description
(Choke Coil)		
L801a,b	LA9430	LUX9430
(Transistor)		
Q801a,b	TR0323	2SC1845
Q802a,b	TR0242	2SC2336
Q803a,b	TR0241	2SA1006
Q808a,b	TR0198	2SC1815
Q809a,b	TR0087	2SA1015
(Semi-Fixed Resistor)		
VR801a,b	RT0123	CR29R 220B
(Capacitor)		
C801a,b	CQ0026T	0.001uF 50V My
C802a,b	CM0125	47pF 500V Mi
C803a,b	CQ0026T	0.001uF 50V My
C804a,b	CM0125	47pF 500V Mi
C805a,b	CE1981	47uF 50V EL
C806a,b	CE1981	47uF 50V EL
C807a,b	CQ1047	0.022uF 400V My

Symbol No.	Stock No.	Description
(Diode)		
D801a,b	TD0227	1SS41
D802a,b	TD5025	1S2462
D803a,b	TD0227	1SS41
D804a,b	TD0227	1SS41
D805a,b	TD5025	1S2462
D806a,b	TD0227	1SS41
(Varistor)		
TY801a,b	TV0026	STV-2H
(Thermistor)		
R802a,b	TV0035	TD5-C230
(Resistor)		
R801a,b	RS1456	820 1/3W Rf
R804a,b	RB0394T	8.2K Rd
R805a,b	RB0394T	8.2K Rd
R818a,b	RS2709L	10 1W Rf
R819a,b	RS2949L	33 2W Rf
R820	RS5035L	1K 1W Rf

### PB1403-2,3 Parts List

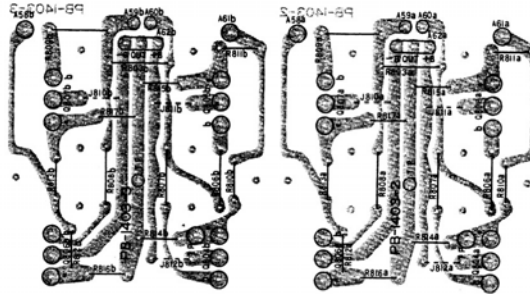

Symbol No.	Stock No.	Description
(Transistor)		
Q804a,b	TR0272	2SC2525
Q805a,b	TR0272	2SC2525
Q806a,b	TR0271	2SA1075
Q808a,b	TR0271	2SA1075
(Resistor)		
R803a,b	RS2717L	100 1W Rf
R806a,b	RS2696L	4.7 1W Rf
R807a,b	RS2696L	4.7 1W Rf
R808a,b	RS2696L	4.7 1W Rf

Symbol No.	Stock No.	Description
R809a,b	RS2696L	4.7 1W Rf
R810a,b	RB0368T	680 Rd
R811a,b	RB0368T	680 Rd
R812a,b	RB0368T	680 Rd
R813a,b	RB0368T	680 Rd
R814a,b	RG0094	0.22 5W Lc
R815a,b	RG0094	0.22 5W Lc
R816a,b	RG0094	0.22 5W Lc
R817a,b	RG0094	0.22 5W Lc

# Schematic Diagram

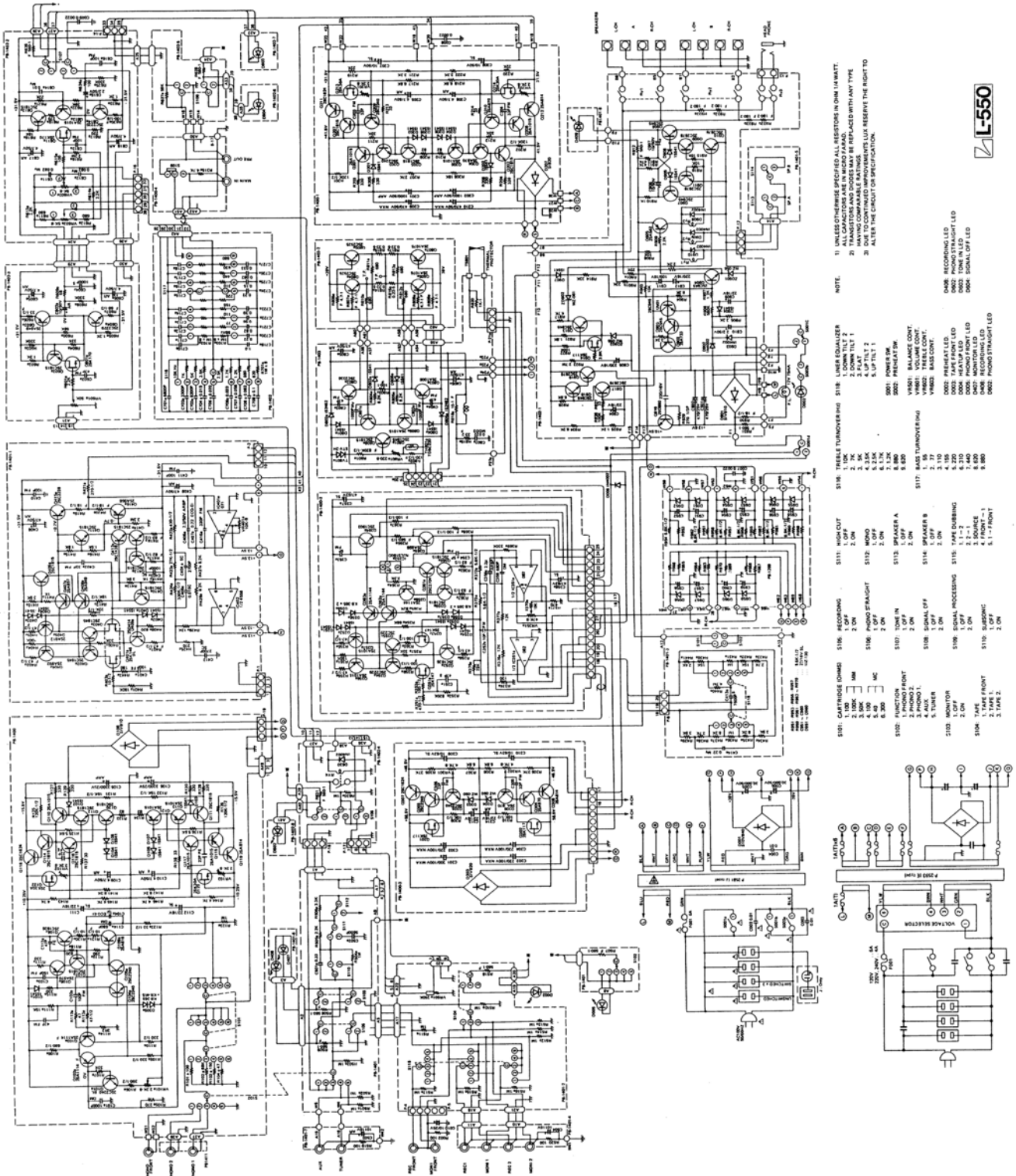

L-550

## Miscellaneous Parts List

Symbol No.	Stock No.	Description	Remarks
(Switch)			
S001	SP0080	SDU4P TV-5	(Power SW)
S002	SP0090	SDG5P502 5A	(Preheating)
(Lamp)			
P.L	AL0070	12V75mA	
(Diode)			
D001	TD0182	S1VB40F	
D002	TD0232	EAA5534S LED, Orange	(Preheating)
D003	TD0233	EBG5534S LED, Green	(Tape-Front Monitor)
D005	TD0233	EBG5534S LED, Green	(Phono-Front)
D006	TD0002	1N4002	
(Fuse)			
F001	BF0118	4A	(EG, EK)
	BF0213	4A(T)	(AG, AK)
	BF0400	6A	(AZ, EZ, J)
(Capacitor)			
C001	CU0081	0.01uF 400V	My (J)
	CU0077	0.01uF 120V	My (J)
C002	CU0081	0.01uF 400V	My (J)
	CU0077	0.01uF 120V	My (J)
C003	CU0081	0.01uF 400V	My (J)
	CU0077	0.01uF 120V	My (J)
C004	CU0077	0.01uF 120V	My (J)
C005	CE1454	30,000uF 50V	EI
C006	CE1454	30,000uF 50V	EI
C011	CE0086	10uF 25V AR	EI
(Resistor)			
R001	RD2662	2.2M	1/2W Rd (J)
R003	RB0348	100	1/4W Rd (J)

## Destination's Parts List

Description	AZ, EZ (120V) Canada & Others	AK (220V) Europe & Others	EK (220V) Europe & Others	AG (240V) England & Oceania	EG (240V) England & Oceania	J (100V) Japan
Rear Panel	UC1209-2	UC1209-3	UC1209-3	UC1209-2	UC1209-2	UC1209-1
AC Cord	BK0018	BK0022	BK0022	BK0023	BK0023	BK0048
Stopper, Cord	BU0033	BU0033	BU0033	BU0039	BU0039	BU0080
Trans, Power	PT2593	PT2593	PT2593	PT2593	PT2593	PT2591
Fuse, (Primary)	BF0400 (6A)	BF0213 (4AT)	BF0118 (4A)	BF0213 (4AT)	BF0118 (4A)	BF0400 (6A)
AC Outlet	AC0010	AC0010	AC0010	AC0010	AC0010	AC0055
Cover, Outlet	Non Use	UJ1107	UJ1107	Non Use	Non Use	Non Use
Voltage Selector Plug:	AC0014	AC0014	AC0014	AC0014	AC0014	Non Use
Socket:	AC0054	AC0054	AC0054	AC0054	AC0054	Non Use

### Remarks

Capacitor: El...Electrolytic, Ce...Ceramic, ST...Styrol, Mi...Mica,  
My...Mylar, Pp...Polypropylene, Fi...Film

Resistor: Rd...Carbon, Rf...Flame Proof, Rc...Cement

All Resistors are in ohm 1/4 Watt.

## IC Handling Guide

**TL-071CP** (IC401a, b : Stock NO. TC0197)

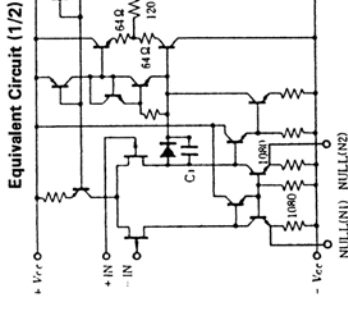
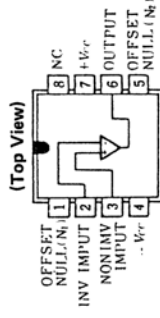

**NJM4558D-D** (IC402 : Stock NO. TC0025)

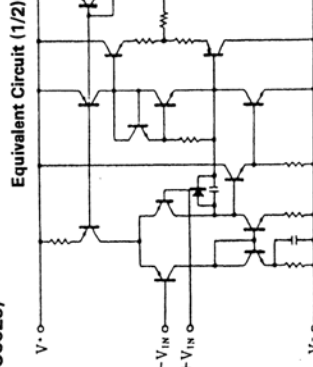
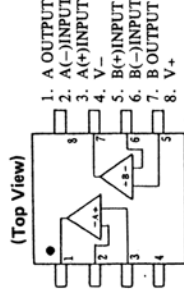

**NJM082** (IC351a, b : Stock NO. 5040)

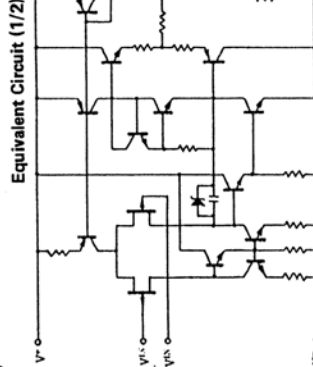
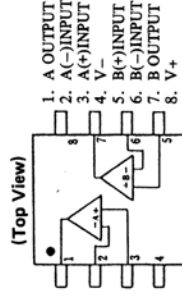

**NJL5160** (IC352a, b : Stock NO. TC0199)

(Top View)

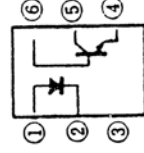

1. LED, A(Anode)
2. LED, K(Cathode)
3. NC
4. Photo TR, E
5. Photo TR, C
6. Photo TR, B

## Specifications

Power Output:	50W + 50W Pure class "A" (8 ohms, both ch. driven 20Hz - 20kHz)
T.H.D.:	no more than 0.005% (8 ohms, -3dB, 20Hz - 20kHz)
Rated I.M.:	no more than 0.005% (8 ohms, -3dB, 60Hz:7kHz=4:1)
Input Sensitivity:	phono (MM): 1.6mV phono (MC): 80uV tuner: 220mV aux: 220mV main in: 220mV
Input Impedance:	phono (MM): 50 kohms, 100 kohms, 100 ohms phono (MC): 100 ohms, 40 ohms, 300 ohms tuner: 33 kohms aux: 33 kohms main in: 47 kohms
Signal-to-Noise Ratio: (IHF-A weighted)	phono (MM): better than 84dB(input short-circuited) phono (MC): better than 67dB(250uV input) tuner: better than 110dB(input short-circuited) aux: better than 110dB(input short-circuited) main in: better than 110dB(input short-circuited)
Frequency Response:	phono(MM,MC): 20Hz - 20,000Hz (within $\pm 0.2$ dB) tuner, aux: 10Hz - 100,000Hz(within -1dB) main in: 10Hz - 100,000Hz(within -1dB)
Tone Control:	maximum variable amount: +9dB Bass Turnover Frequencies: 55Hz,77Hz,110Hz,155Hz, 220Hz,310Hz,440Hz,620Hz, 880Hz Treble Turnover Frequencies: 620Hz,880Hz,1.2kHz,1.7kHz, 2.5kHz,3.5kHz,5kHz,7kHz, 10kHz
Preamplifier Output:	220mV
Additional Features:	Subsonic Filter (15Hz), High Cut Filter (9kHz), Pre-Heating Switch, Warm-Up Indicator, Phono Straight Switch, Signal OFF Switch, Linear Equalizer, Tone-In Switch, REC Switch, Tape Monitor Switch(tape-1, tape-2, tape-front), Tape Dubbing Switch(1 $\blacktriangleright$ 2, 2 $\blacktriangleright$ 1, 1 $\blacktriangleright$ front front $\blacktriangleright$ 1), Speaker Selector (A,B), Headphone Jack, etc.
Dimensions:	453(W) x 460(D) x 174(H)mm (17.8" x 18.1" x 6.9")
Weight:	Net 18kgs (39.6 lbs.)

Specifications and appearance design subject to change without notice.

L-550



**LUX CORPORATION, JAPAN**

1-1, 1-CHOME, SHINSENRI-NISHIMACHI, TOYONAKA HI, OSAKA 565  
PHONE: 06-834-0004 CABLE LUXMAN TOYONAKA TELE: 6287106 LUXELE J

L-NK.8306.012A Printed in Japan